

Foot switches and Safety foot switches

Product overview



SCHMERSAL

Foot switches and

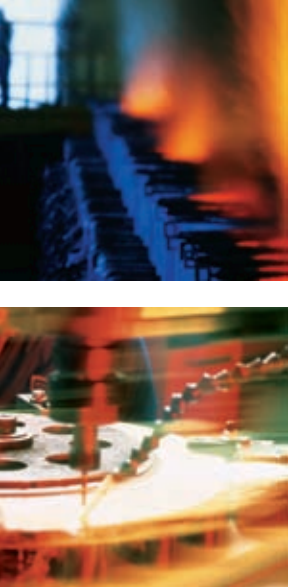

Range of application

Foot switches are used to start and stop operations and production processes on machinery and plants, where actuation by hand is impossible.

Depending on the environmental conditions and the mechanical load, different variants of foot switches are available.

The robust foot switches of the .F.232 series are generally used e.g. on presses, punching and bending machines as well as in sheet-steel processing.

Safety foot switches are used as enabling switches on machinery and plants, where actuation by hand is impossible.

Design and operating principle

All foot switches of the .F. 232 series are available in 2-pedal version.

The foot switches of the .FH 232 series are equipped with an ergonomic protective shield to protect against unintentional actuation.

The pedals can be smoothly operated, even with safety shoes. The protective shield is largely dimensioned and has a fold on the inside, which facilitates the conscientious positioning of the switch by foot.

The powder-coated, robust die-cast enclosures with neutral colour can resist to high mechanical loads. The large wiring compartment enables a smooth and fast installation of the foot switch.

The foot switches are available with pressure point, bi-stable function ("start/stop" principle) and latching element.

The .F. 232 series is approved in accordance with cULus (North-America) and CCC (China).



Safety foot switches

Safety foot switches

The safety foot switches are equipped with an ergonomic protective shield against unintentional actuation. When the foot pedal is actuated to as far as the pressure point, the NO contact is closed. If the foot pedal is actuated beyond the pressure point in case of danger, the positive break NC contact is opened and mechanically locked.

Reset operation is carried out by means of the blue push button, located on the topside of the cover. The rubber cap of the reset button simultaneously protects the inner compartment of the foot switch against moisture, dust and dirt.

Bi-stable function ("start/stop" principle)

The bi-stable function ("ball point" or "start/stop" principle) is realised by means of switching elements. When the foot pedal is actuated for the first time, the switch insert is activated (= ON). A second action on the pedal will neutralize the latching force and release the switch insert (= OFF). The foot switch thus is used as "start/stop" contact.

3-phase actuation with pressure point

The 3-phase operation is realised through the pressure point, located under the foot pedal. When the pedal is in top position, i.e. not actuated, the machine is idle. As soon as the pedal is actuated, the first NO contact is closed; the pedal travel is limited by the end stop of the pressure point. The machine is running.

Whenever the pedal is actuated beyond the pressure point, e.g. because of the operator exercising excessive pressure in case of danger or due to pain, the second NO contact is closed. The first contact however remains active.

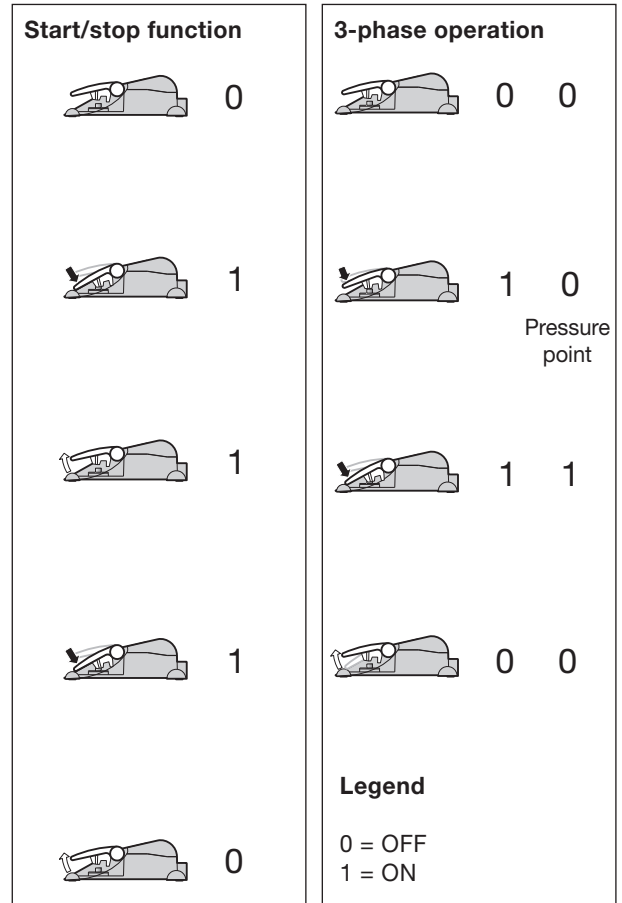

Foot switches

.F. 232

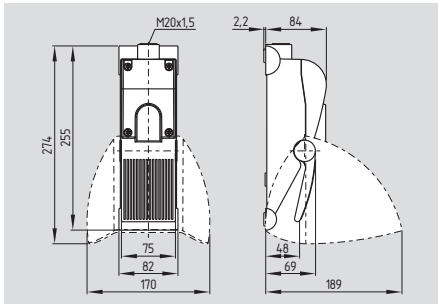
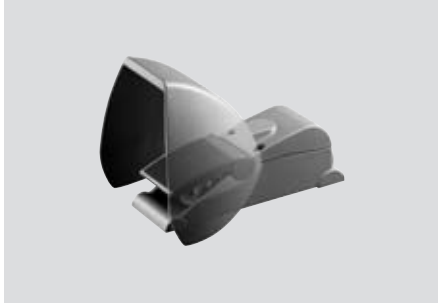

- Single-pedal type
- With or without protective shield
- Max. 4 contacts per pedal
- Metal enclosure
- High level of stability
- Wide opening in shield
- Low pedal height
- Cable entry M20 x 1.5
- Available with start/stop function
- 3-phase actuation with pressure point available
- Also available as safety foot switch

.2F. 232

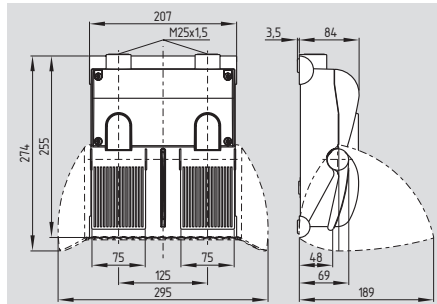
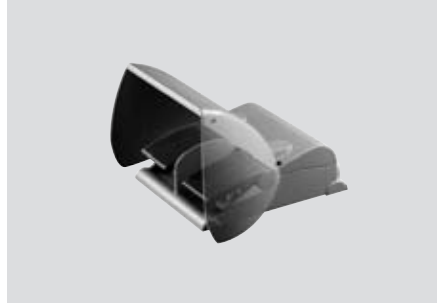

- Double-pedal type
- With or without protective shield
- Max. 4 contacts per pedal
- Metal enclosure
- High level of stability
- Wide opening in shield
- Low pedal height
- Cable entry 2x M25 x 1.5
- 3-phase actuation with pressure point available

Technical data

Standards:	IEC/EN 60947-5-1 VDE 0113 part 1
Enclosure, Cover, Protective shield:	aluminium die-cast, powder-coated, RAL 9006
Pedal:	glass-fibre reinforced thermoplastic
Connection:	screw terminals
Cable section:	max. 2.5 mm ² (incl. conductor ferrules)
Cable entry:	single-pedal : M20 x 1,5 double-pedal: 2 x M25 x 1,5
Protection class:	IP 65 to IEC/EN 60529
Switching system:	slow or snap action
U _{imp} :	6 kV
U _i :	500 V
Utilisation category:	AC-15, DC-13
I _e /U _e :	4 A / 230 VAC 1 A / 24 VDC
Max. fuse rating:	6 A gG D-fuse to DIN EN 60269-1
Ambient temperature:	- 25 °C ... + 70 °C
Mechanical life:	> 1 million operations with start/stop function: > 700.000 operations

Approvals

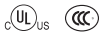

Approvals

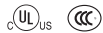

Ordering details

①F② 232-③-④		Single-pedal type
No.	Replace	Description
①	T	Slow action
	Z	Snap action
②	H	Without protective shield
	H	With protective shield
③	11	1 NO/1 NC
	02	2 NC
	20	2 NO
	22	2 NO/2 NC
	04	4 NC
	40	4 NO
④	hd	3-phase actuation with pressure point
	f	Start/stop function

Ordering details

①2F② 232-③-④		Double-pedal type
No.	Replace	Description
①	T	Slow action
	Z	Snap action
②	H	Without protective shield
	H	With protective shield
③	11/11	1 NO/1 NC
	02/02	2 NC
	20/20	2 NO
	22/22	2 NO/2 NC
	04/04	4 NC
	40/40	4 NO
④	hd	3-phase actuation with pressure point

Note

When ordering, please note:

3-phase actuation with pressure point
The pressure point can only be ordered for 2 NO or 4 NO contacts (③ = 20 or 40) per pedal and is exclusively available with slow action (① = T). The pressure point must be indicated separately for each contact type, e.g. **TF② 232-③hd**
T2F② 232-③hd/③hd

Start/stop function
The start/stop function is exclusively available with one switch insert per pedal (③ = 11 or 02) and slow action (① = T), e.g. **TF② 232-③f**

Foot switches

Contact variants

Per pedal:

1 NO/1 NC

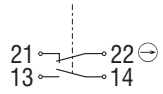

2 NC

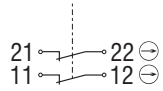

2 NO

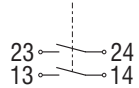

2 NO/2 NC

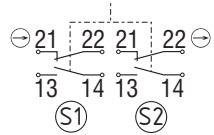

4 NC

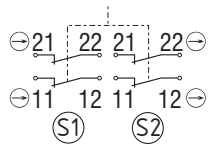

4 NO

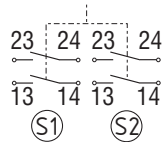

System components

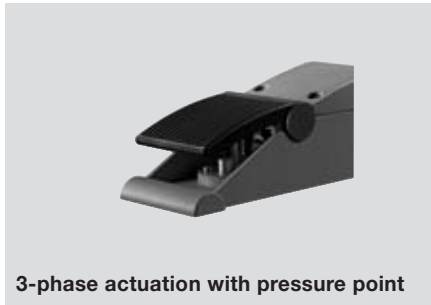

3-phase actuation with pressure point

Note

Other contact configurations available on request (Max. 4 contacts per pedal).

Ordering details

3-phase actuation
with pressure point
Start/stop function
(without image)

Ordering suffix hd

Ordering suffix f

Safety foot switches

TFH 232-...üdr

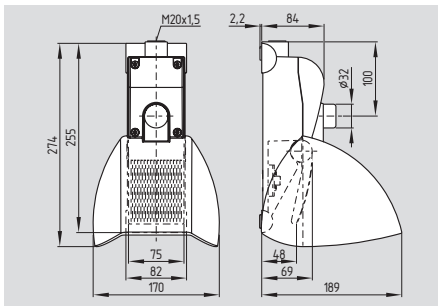
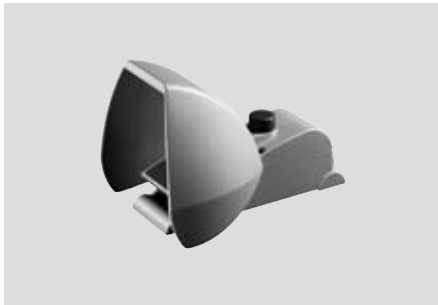

- 2 contacts
- Metal enclosure
- Protective shield with wide opening
- Low pedal height
- High level of stability
- Cable entry M20 x 1.5

Technical data

Standards:	IEC/EN 60947-5-1 DIN VDE 0660-200 BG-GS-ET-15
Enclosure, Cover, Protective shield:	aluminium die-cast, powder-coated, RAL 9006
Pedal:	glass-fibre reinforced thermoplastic
Connection:	screw terminals
Cable section:	max. 2.5 mm ² (incl. conductor ferrules)
Cable entry:	1 x M20 x 1.5
Protection class:	IP 65 to IEC/EN 60529
Switching system:	⊖ IEC 60947-5-1 slow action, NC contact with positive break
Contacts:	1 NO / 1 NC
U _{imp} :	6 kV
U _i :	500 V
I _{the} :	10 A
Utilisation category:	AC-15, DC-13
I _e /U _e :	4 A / 230 VAC 1 A / 24 VDC
Max. fuse rating:	6 A gG D-fuse to DIN EN 60269-1
Ambient temperature:	- 25 °C ... + 70 °C
Mechanical life:	> 1 million operations

Contact variants

1 NO/1 NC

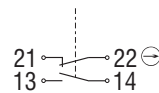

Approvals

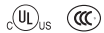

Ordering details

TFH 232-11-üdr

Mode of operation

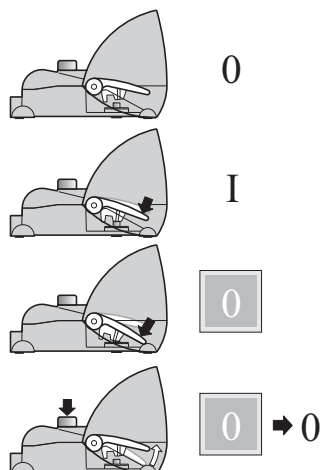

Around the clock

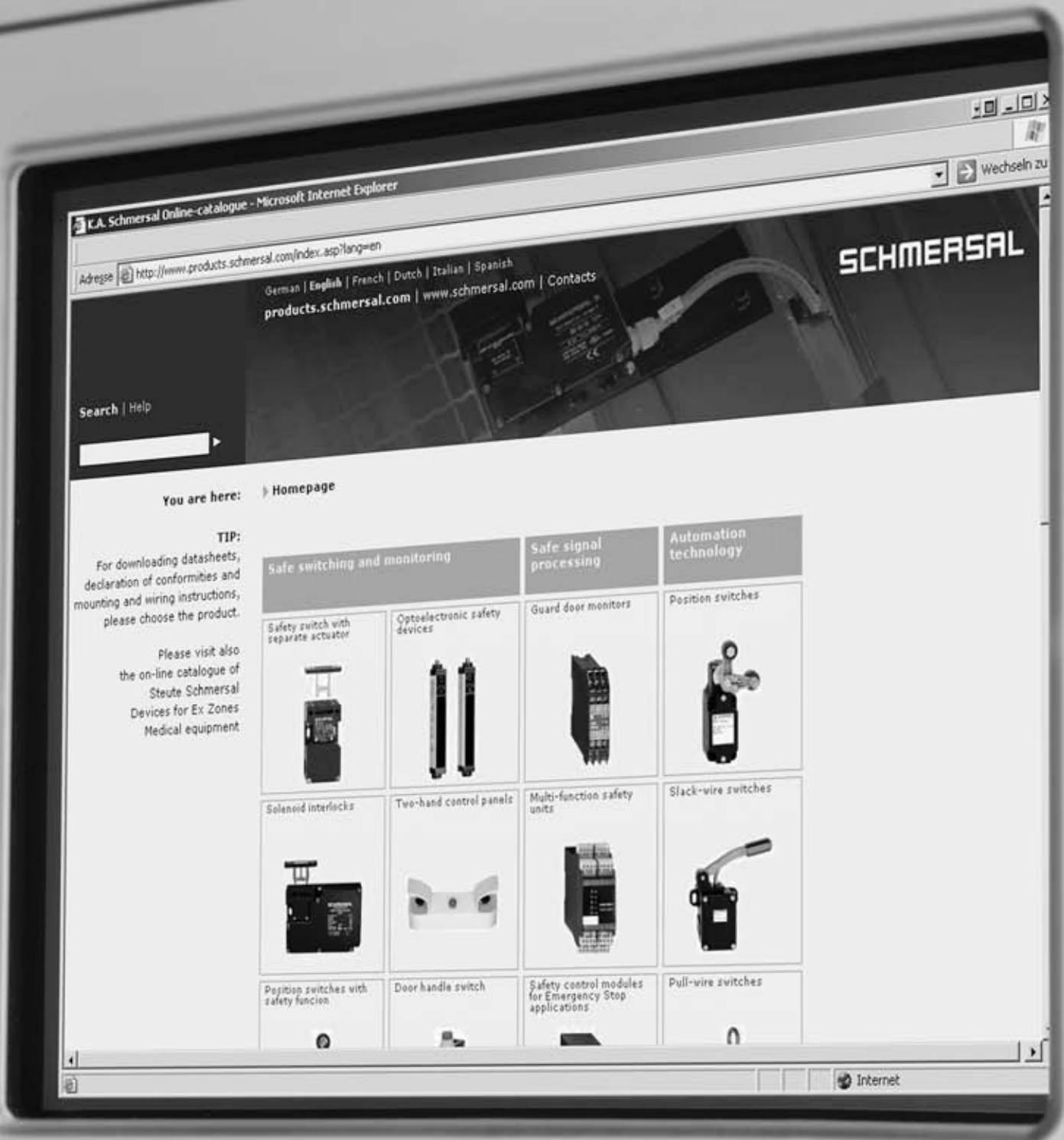

Always there for you, the Online Catalogue at:
www.schmersal.com

K.A. Schmersal GmbH
Industrielle Sicherheitssysteme

Möddinghofe 30
D-42279 Wuppertal
Postfach 24 02 63
D-42232 Wuppertal

Telefon +49 - (0)2 02 - 64 74 - 0
Telefax +49 - (0)2 02 - 64 74 - 1 00

E-Mail info@schmersal.de
Internet <http://www.schmersal.com>